

How Our Technical Sales Team Can Help You - As Easy As 1,2,3

Although CRL offers thousands of stock products with short lead times, custom designs will require more time and planning. This is when CRL excels. All we require from you is a drawing that puts to paper your vision of the final product. Our Technical Sales Representatives will then work with you to take this image to a new phase. Architectural drawings can be created, and ideas exchanged until the final ordering and production process takes place. The example below shows how a simple black and white drawing evolved into the final product that pleased our customer and, more importantly, their customer.

Customer's Rough Drawing of Counter Top Condition and Design Concept

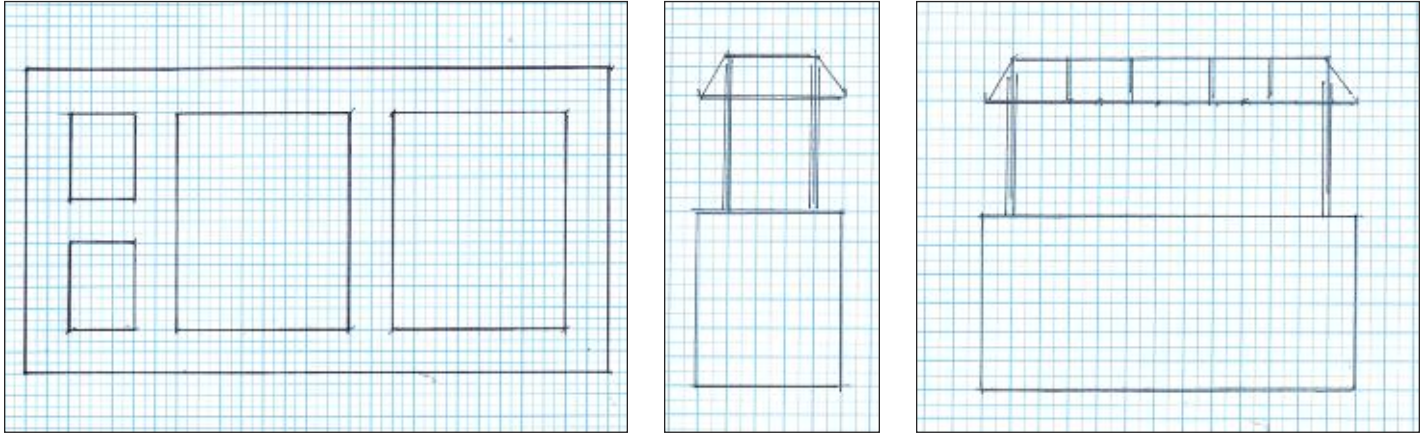

CRL Architectural Drawing Ordered by Customer for End User Approval

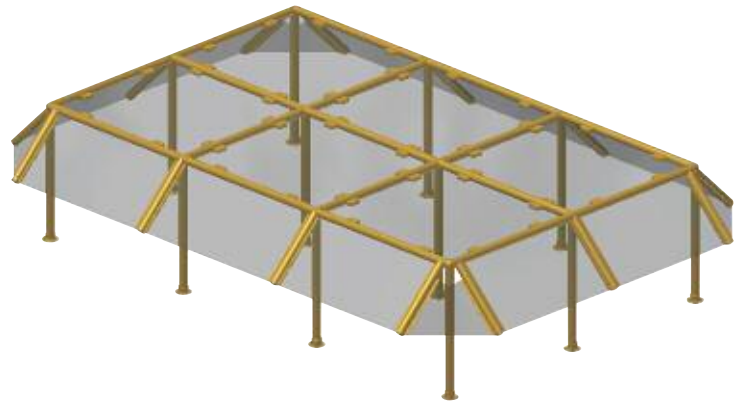
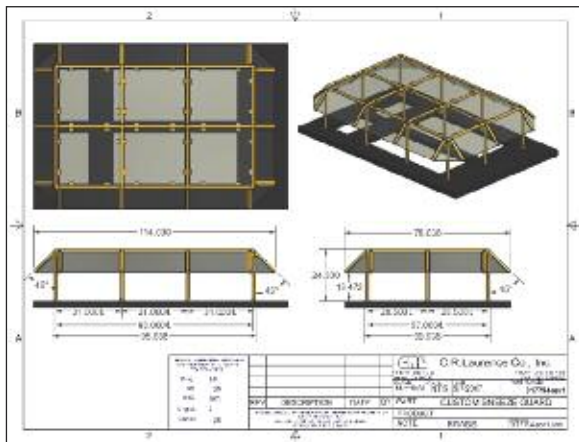

Finished Product Right After Production



CRL Guidelines for Self-Service Open Front Food Bars



Regulations for Self-Service Sneeze Guards are set by national standards or by the local Health Department. After fabricating numerous Sneeze Guards for various food establishments we have narrowed down what we feel is acceptable in most jurisdictions for Self-Service Open Front Food Bars. The illustration to the right is our guideline, however the local Health Department or Building Department should be contacted as some have additional or stricter regulations.

Basically the CRL guidelines have been accepted by most jurisdictions across the country, however if you have any additional requirements placed on you, we will do our best to cover those requirements.

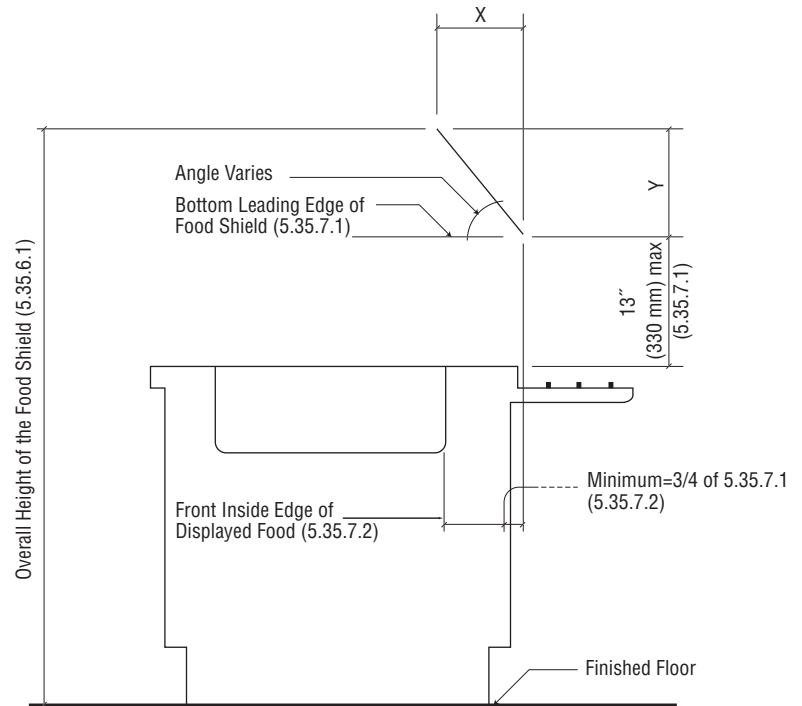

General Explanations on Food Service Barriers

What are Partition and Barrier Posts?

CRL Partition and Barrier Posts provide an almost invisible barrier between the customer and the food preparation areas. Partitions are vertical glass walls held in place by partition posts. They are designed to protect the food, and keep the customer from having any access to it. In recent years a lot of the food preparation has moved from the kitchen to the service line. No service is offered in this area, but visually it allows the customer to view the various selections being prepared and help determine their choice of entree. Partitions are also used as Booth Dividers and Area Separation Walls. The large variety of shapes, finishes, and sizes will cover most stock and custom applications.



What are Sneeze Guards and Food Shields?



Full Service Models



Self-Service Models

CRL Sneeze Guards and Food Shields protect food from sneezes and provide protection from the human breath zone. They fall into two categories: Full Service models that restrict access to the food by the customer, and usually have a top shelf for plated foods that are assembled by a server; Self-Service models (commonly used at Salad Bars) that allow the customer to serve themselves. This usually consists of a slanted piece of glass that protects the food from the breath zone as specified by CRL (see guidelines above). Full Service and Self-Service models are frequently combined to suit the needs of various dining establishments.

Design Guidelines for CRL Partition Posts and Sneeze Guards

- **Basic Measurements to Keep in Mind While Designing Your Service Areas**

A big part of a successful project is the initial layout and design. You want to make sure that your plans are attainable using the selected CRL hardware, and that you aren't creating a design that will run into roadblocks later in the process.

The information below is intended to assist your design process. As always, we offer technical assistance for all of your projects. Contact the Hospitality Technical Sales Department at (800) 421-6144 in the U.S., (877) 421-6144 from Canada, or (323) 588-1281 International. You can send email from the home page of crlaurence.com. Click on Contact Us, and then click on Technical Sales for Hospitality Products.

Maximum Spans Between Uprights (Per GANA Guidelines)

DESIGN SERIES AND SCULPTURE SERIES ALUMINUM PARTITION POSTS AND SNEEZE GUARDS

Our Design Series and Sculpture Series Aluminum Posts and Sneeze Guards are designed to accept 1/4" (6 mm) glazing. The maximum recommended span between uprights is 36" (914 mm).

PLAZA, ELEGANT, CONTEMPORARY, TIGHT-FIT, AND SLIMLINE SERIES STAINLESS STEEL AND BRASS PARTITION POSTS AND SNEEZE GUARDS

Our stainless steel and brass posts can be used with glass from 1/4" to 1/2" (6 to 12 mm) thick. For 1/4" (6 mm) glass the maximum recommended span between uprights is 42"; for 3/8" (10 mm) glass the maximum span is 56" (1422 mm); for 1/2" (12 mm) glass the maximum span is 72" (1829 mm).

Glass Deductions for Stainless Steel and Brass Tubing Posts

MEASURED CENTER-TO-CENTER OF POSTS		ROUND TUBING			SQUARE TUBING
HARDWARE	GLASS THICKNESS	1" (25.4 MM) DIAMETER	1-1/2" (38.1 MM) DIAMETER	2" (50.8 MM) DIAMETER	1-1/2" (38.1 MM) SQUARE
STAINLESS STEEL U-CHANNEL	1/4" (6 mm) and 3/8" (10 mm)	1-1/4" (31.7 mm) Deduction	1-3/4" (44.5 mm) Deduction	2-1/4" (57.1 mm) Deduction	2-3/8" (60.3 mm) Deduction
BRASS U-CHANNEL	1/4" (6 mm) and 3/8" (10 mm)	Not Applicable	1-13/16" (46 mm) Deduction	2-5/16" (58.7 mm) Deduction	Not Applicable
GLASS FITTINGS	1/4" (6 mm) and 3/8" (10 mm)	1-7/8" (47.6 mm) Deduction	2-3/8" (60.3 mm) Deduction	Not Applicable	2" (50.8 mm) Deduction
GLASS CLIPS	1/4" (6 mm) and 3/8" (10 mm)	Not Applicable	2-3/16" (55.6 mm) Deduction	Not Applicable	2-3/16" (55.6 mm) Deduction
Z-CLAMPS # Some Z-Clamps have an option for a notch in the glass.	1/4" (6 mm)	1-13/16" (46 mm) Deduction	3-1/16" (77.8 mm) Deduction	3-9/16" (90.5 mm) Deduction	3-1/16" (77.8 mm) Deduction
	3/8" (10 mm)	2-9/16" (65.1 mm) Deduction	#	#	#
	1/2" (12 mm)	Not Applicable			

Glass Deductions for Design Series Aluminum Posts

Design Series 1-1/8" (28.6 mm) square extruded aluminum Partition Posts accept 1/4" (6 mm) glass in u-channels affixed to the vertical edges. The glass deduction is 1-7/16" (36.5 mm) from the center-to-center measurement between posts.

NOTE: Deductions are based on CRL recommended measurements to achieve a secure glass fit between uprights. As with any project, your conditions may vary, and extra care should be taken to make exact measurements.



CRL Design Series Custom Partition Posts

- Custom Units Fabricated and Ready to Ship From Los Angeles Within 3 to 5 Working Days
- 1-1/8" (28.6 mm) Square Aluminum Extrusion for Use With 1/4" (6 mm) Glazing
- Available in Satin, Brite, and Brite Gold Anodized, Plus Duranodic Bronze

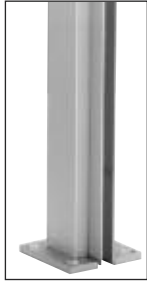

D990 Series Post Full Length Channel 2" x 2" (51 mm) Base



D991 Series Post Channel With Air Space 2" x 2" (51 mm) Base



D992 Series Post Full Length Channel 2" x 3" (51 x 76 mm) Base

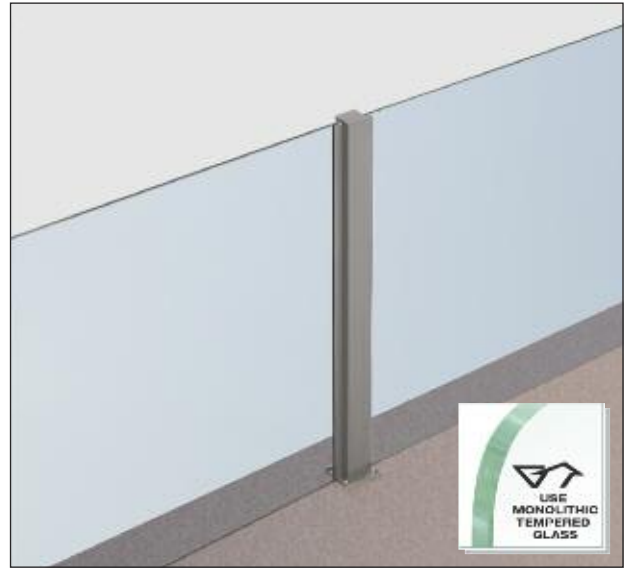

Maximum Post Spacing Using 1/4" (6 mm) Glass is 42" (1067 mm)



In addition to our stock Design Series Aluminum Partition Posts, CRL offers Custom Design Series Aluminum Partition Posts fabricated using our 1-1/8" (28.6 mm) square aluminum extrusion. Finishes include Satin Anodized, Brite Anodized, Brite Gold Anodized, and Duranodic Bronze. U-Channels for 1/4" (6 mm) glass, Standard or Deluxe Caps, and different Base Plates let you design posts to meet your special order needs. A step by step Quote/Order process is provided below to assist you in your selection. Custom Partition Posts will be fabricated and ready to ship from Los Angeles, California within three to five working days. CRL has weekly re-supply trucks that stock our many warehouses around the U.S. and Canada. If time is not an issue we can arrange for our re-supply truck to get your Custom Posts to your local CRL branch for shipment. (Please allow seven to ten working days.)

Custom Design Series Post Quote/Order Steps

1. Specify Post Style and Quantity

- End Qty. _____ Center Qty. _____ Corner Qty. _____ 3-Way Qty. _____ 4-Way Qty. _____

Special 135 Degree Angle Posts

- Left 135° End Qty. _____ Right 135° End Qty. _____ 135° Center Qty. _____
 Left 135° Center Qty. _____ Right 135° Center Qty. _____

2. Select a Finish

- Satin Anodized Brite Gold Anodized
 Brite Anodized Duranodic Bronze
 Powder Painted RAL Color # _____

3. Specify Post Height in Inches _____

Maximum Height for Design Series Posts is 36" (914 mm).

4. Specify Air Space in Inches If Required _____

Air space is measured from counter top to bottom edge of glass for lower air space, or from top edge of glass to top of Post Cap for upper air space.

*Each Custom Post includes a Top Cap and appropriate Mounting Base with four Mounting Screws.

Plan View of Divider Assembly Showing Post Placement

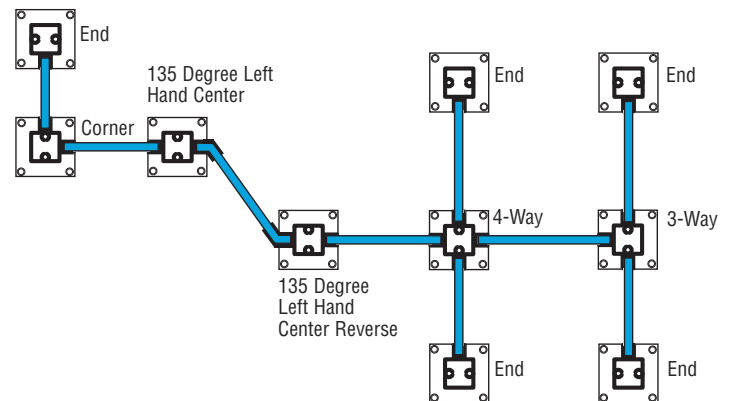

For Quote or Order Information, contact CRL Technical Sales at (800) 421-6144 in the U.S., (877) 421-6144 from Canada, or (323) 588-1281 International. Ask for Ext. 7760. You can also E-mail us through our web site at crlaurence.com. From the home page click on Contact Us, and then click on Technical Sales.





CRL Design Series Partition Posts

Special Ordering Information

CRL Design Series Partition Posts offer you complete flexibility because the selection of styles, finishes, and configurations is so varied. But to be sure you get the posts exactly to your specifications we request you consider each of the requirements shown below when ordering or submitting a request for prices. Since custom posts are made especially to your order, they are non-returnable after fabrication. In some instances, we may request you submit a diagram of your proposed post layout prior to fabrication of your order. When planning your order, be sure to consider in your glazing requirements, the thickness of the posts between glazing panels.

Seven Simple Steps:

1. When Ordering Specify Post Style and Order By Number

D990 Standard	D991 Air Space
D992 Extra Tall	D995 Top Shelf
D996 Slant Front	D997 Smorgasbord
D998 Tee	D980 Wicket Frame

2. Specify Finish Desired:

A - Satin Anodized
 DU - Duranodic Bronze
 BA - Brite Anodized*
 BGA - Brite Gold Anodized*
 *Not available in all post styles

3. Specify Post Height:

D990 has three stock heights: 12", 18" and 24" (305, 610, and 914 mm). All others are custom made to order. Height is measured from top of post cap to counter surface.

4. Specify Air Space (If Required):

Air space is measured from counter surface to the bottom edge of glass for lower air space-or-from top edge of glass to top of post cap for upper air space.

5. Specify Shelf Size:

D995, D996, D997 and D998 style Posts accommodate top shelves. Minimum width is 6" (152 mm), maximum width is 14" (355 mm).

6. Specify Glazing Information:

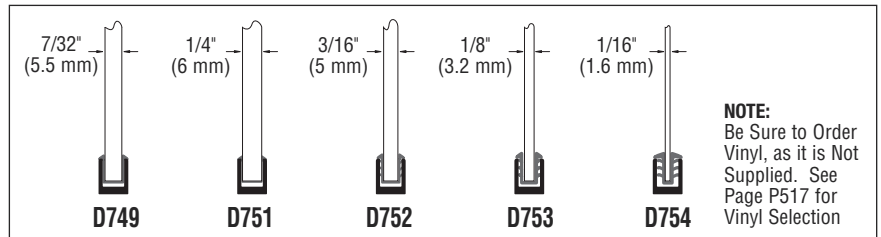

CRL Design Series Partition Posts come with 5/16" (8 mm) U-Channel which can be used to glaze five different thicknesses of materials.

7. Specify Post Configuration:

All Design Series Posts are surface mounted. Vertical channel accepts glass of 1/4" (6 mm) or less thickness. All Posts are manufactured from 1-1/8" (28.6 mm) square extruded aluminum tubing.



Standard 2" x 2" (50.8 x 50.8 mm) Base D990/ D991 Style Posts

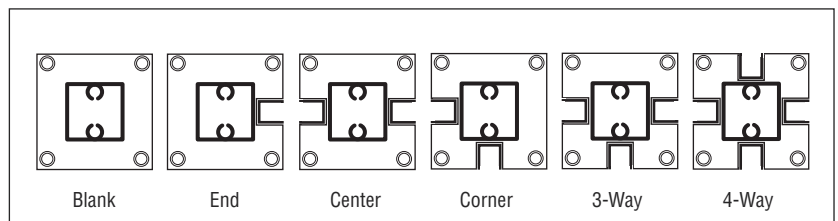

Special 135 Degree Angle D990/ D991/ D992 Style Posts

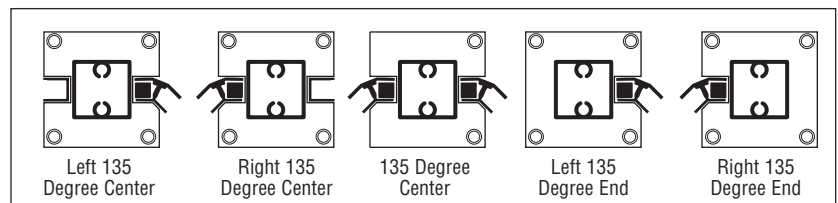

2" x 3" (50.8 x 76.2 mm) Base and Brace D992/ D995/ D996 Heavy-Duty Style Posts

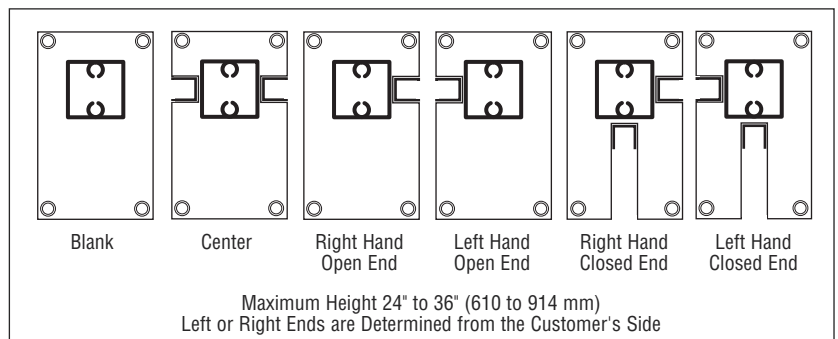

CRL Design Series Quote/Order Form - Page 1 of 2

Select Style

D995 Post

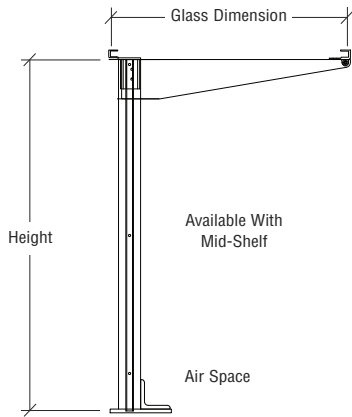

D996 Post

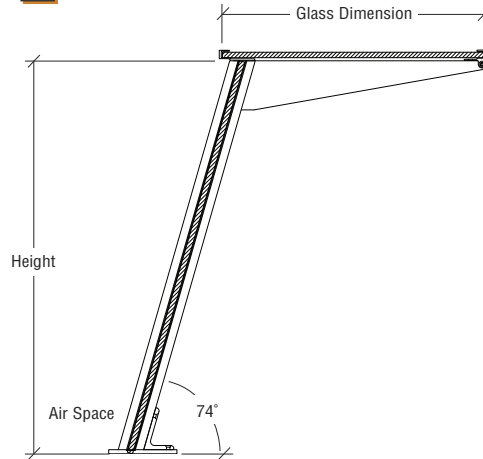

D997 Post

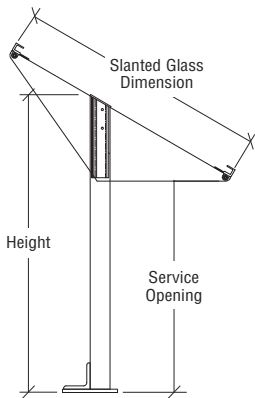

D998 Post

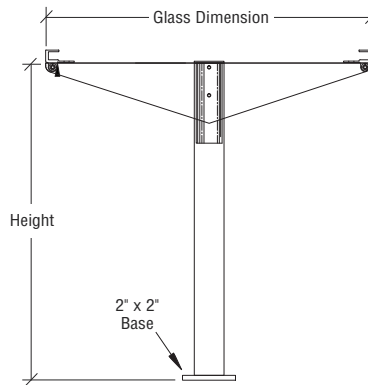

D999 Post

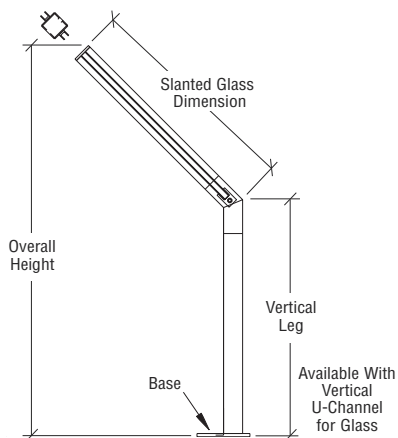

Specify Dimensions

(see pages P518-P519 for maximum sizes)

- _____ Air Space Dimension
- _____ Glass Dimension
- _____ Height or Vertical Leg Dimension
- _____ Service Opening
(Not Necessary If Vertical Leg Dimension Given)
- _____ Overall Height
(Not Necessary If Vertical Leg and Shelf Dimension Given)

CRL CUSTOM DESIGN SERIES SNEEZE GUARDS

For Pricing Visit Our Web Site or Call Us Toll Free at the Phone Numbers Shown on the Back Cover

CRL Design Series Quote/Order Form - Page 2 of 2

Finish

- Satin Anodized
- Brite Anodized
- Brite Gold Anodized
- Duranodic Bronze

U-Channel

- 1/4" (6 mm)

Top Bracket Size

- 14" (356 mm)
- 12" (305 mm)
- 10" (254 mm)
- 8" (203 mm)
- 6" (152 mm)
- Custom Bracket Size _____

Mid-Shelf Size (On D995 Only)

- 8" (203 mm)
- 6" (152 mm)

Handings are Taken from Customer Side

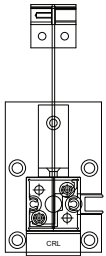

Left Open End

Quantity _____

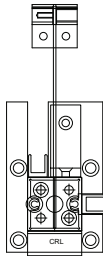

Left Closed End

Quantity _____

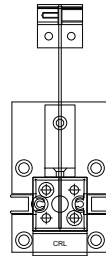

Center Post

Quantity _____

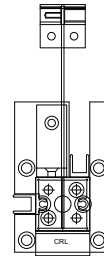

Right Closed End

Quantity _____

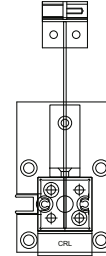

Right Open End

Quantity _____

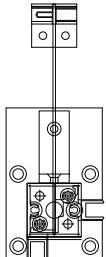

Left Open Reverse

Quantity _____

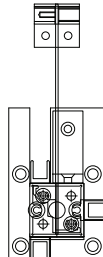

Left Closed Reverse

Quantity _____

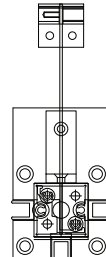

Center Closed Reverse

Quantity _____

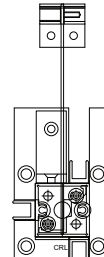

Right Closed Reverse

Quantity _____

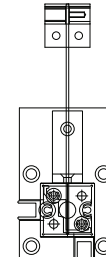

Right Open Reverse

Quantity _____

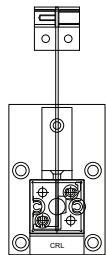

Blank

Quantity _____

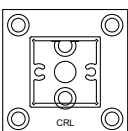

**2 x 2 Base
On D998 Only**

Sample Layout for Return with D995

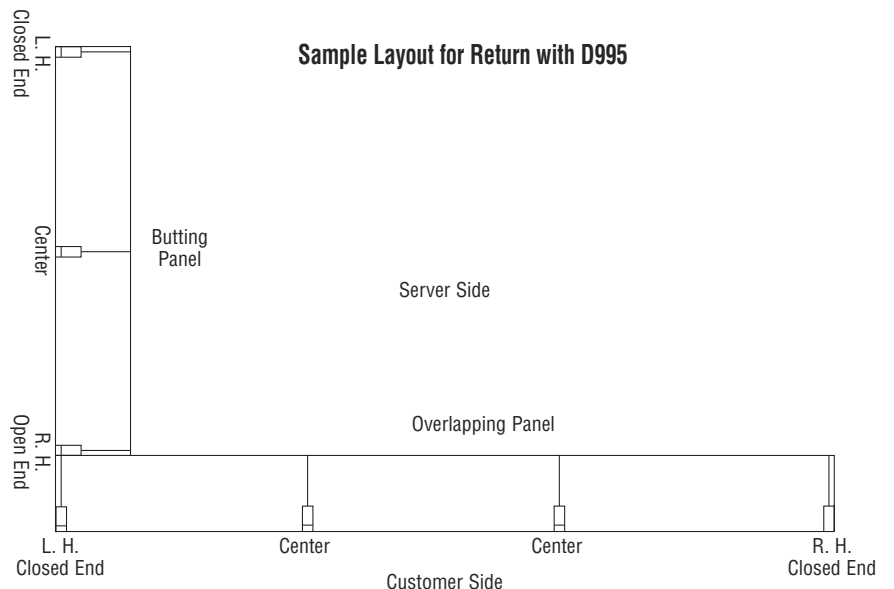

CRL Sculptured Series Custom Aluminum Partition Posts

- Custom Units Fabricated and Ready to Ship From Los Angeles in Three to Five Working Days
- For Use With 1/4" (6 mm) Glazing
- Posts Can Be Fabricated Up to 36" (914 mm) Tall
- Available in Satin Anodized, Buffed Brite Anodized, Duranodic Bronze, and Powder Painted Finishes

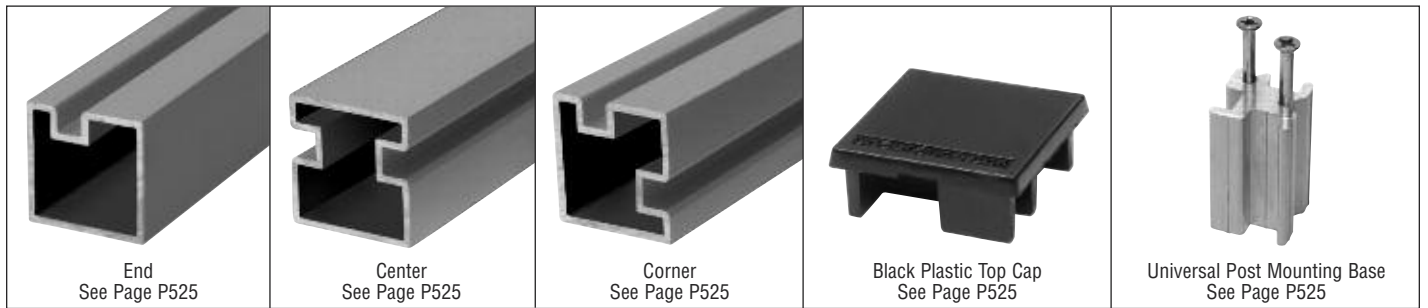
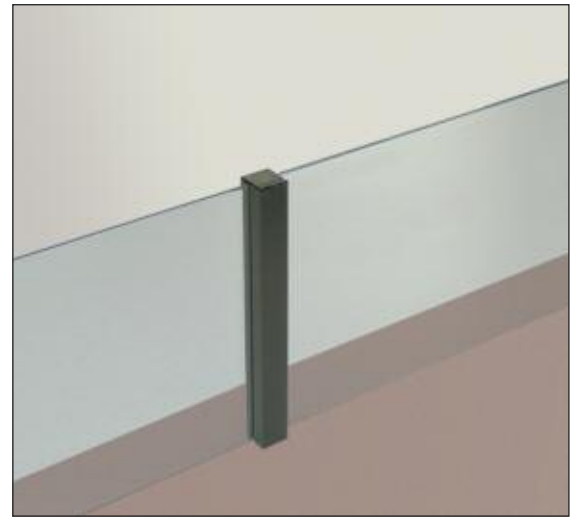

Our line of Sculptured Series Aluminum Partition Posts can also be custom made to order. Square Aluminum Extrusion is available in Satin Anodized, Buffed Brite Anodized, and Duranodic Bronze finishes. Recessed channel holds 7/32" to 1/4" (5.5 to 6 mm) glass. Included Black Top Cap and Universal Post Mounting Base fit snugly in the Extrusion. A step-by-step Quote/Order process is provided below to assist you in your selection. Custom Partition Posts will be fabricated and ready to ship from Los Angeles, California within three to five working days. CRL has weekly re-supply trucks which stock our many warehouses around the U.S. and Canada. If time is not an issue we can arrange for our truck to get your Custom Posts to your local CRL branch for shipment. Please allow for seven to ten working days.

Plan View of Divider Assembly Showing Post Placement

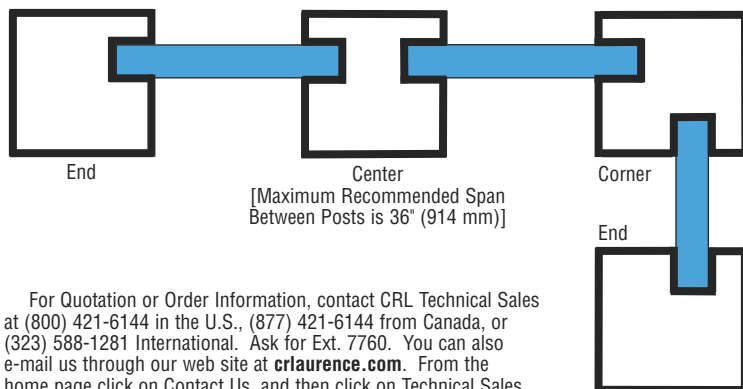

For Quotation or Order Information, contact CRL Technical Sales at (800) 421-6144 in the U.S., (877) 421-6144 from Canada, or (323) 588-1281 International. Ask for Ext. 7760. You can also e-mail us through our web site at crlaurence.com. From the home page click on Contact Us, and then click on Technical Sales.

Custom Sculptured Series Post Quote/Order Steps

1. Specify Post Style and Quantity
 _____ End _____ Center _____ Corner
2. Select a Finish Satin Anodized Duranodic Bronze
 Buffed Brite Anodized
 Powder Painted RAL Color # _____
3. Specify Post Height in Inches _____

Each Custom Post Includes a Plastic Top Cap and Universal Mounting Base with Two Screws.

CRL CUSTOM SQUARE PARTITION POSTS

For Pricing Visit Our Web Site or Call Us Toll Free at the Phone Numbers Shown on the Back Cover

CRL Plaza Series Custom Square Partition Posts



- 1-1/2" (38.1 mm) Square Tubing for Use With 1/4", 3/8" or 1/2" (6, 10 or 12 mm) Glazing
- Posts Ready to Ship in Three to Five Days From Los Angeles
- Heights of Posts Can Be Customized
- Available in Polished or Brushed Stainless Steel, or Powder Painted Finishes

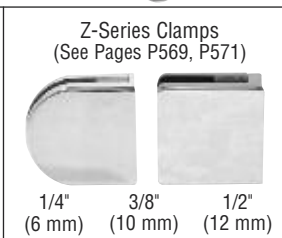
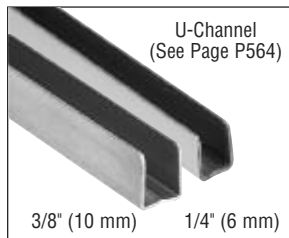
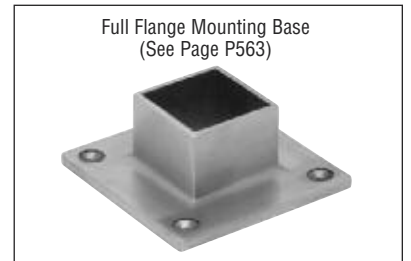
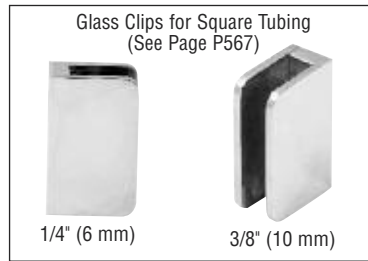
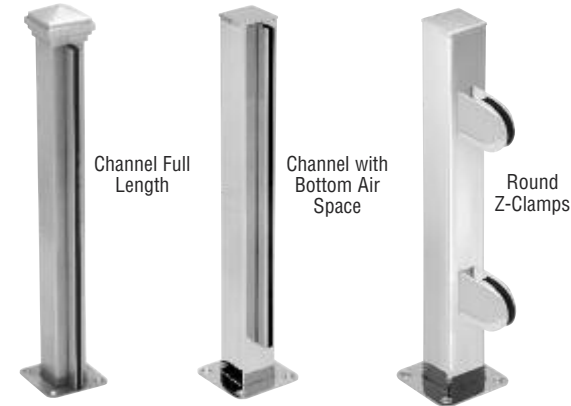

In addition to our Stock and Prefabricated Posts we offer an extensive line of Custom Fabricated Posts. They are available in 1-1/2" (38.1 mm) Square Tubing. Finishes include Brushed Stainless, Polished Stainless, and Powder Painted. Different glass attachments (U-Channel, Z-Clamps or Glass Clips) in various glass thicknesses are available. A selection of Caps and Bases let you design Posts to match your décor. A step by step Quote/Order process is provided to assist you in your selection. Custom Partition Posts will be fabricated and ready to ship from Los Angeles, California within three to five working days. CRL has weekly re-supply trucks that stock our many warehouses around the U.S. and Canada. If time is not an issue we can arrange for our re-supply truck to get your Custom Posts to your local CRL branch for shipment. Please allow seven to ten working days.

Plan View of Divider Assembly Showing Post Placement

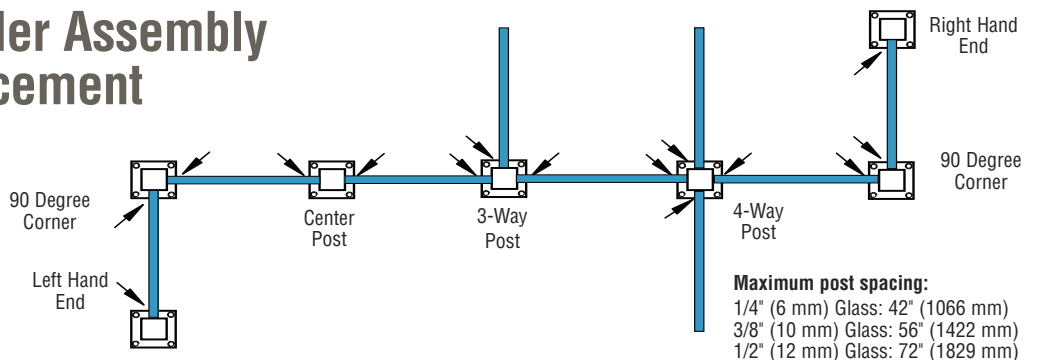

CRL Plaza Series Sneeze Guards (see page P532)



CRL Plaza Series Custom Square Partition Posts Quote/Order Form – Page 1 of 2

Select Tubing

See page P558.



1"
(25.4 mm)



1-1/2"
(38.1 mm)



Select a Finish



#4 Brushed Stainless



#8 Polished Stainless



Powder Paint RAL Color # _____



Post Style and Dimensions

NOTE: If you have more than one style, use a separate form for each style.

Channel with Bottom Air Space



1/4" (6 mm) Glass Channel



3/8" (10 mm) Glass Channel



1/2" (12 mm) Glass Channel

H = Post Height _____"

C = Channel Length _____"

A = Air Space _____"

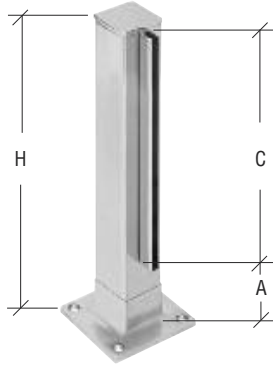

Full Length Channel



1/4" (6 mm) Glass Channel



3/8" (10 mm) Glass Channel



1/2" (12 mm) Glass Channel

H = Post Height _____"

C = Channel Length _____"

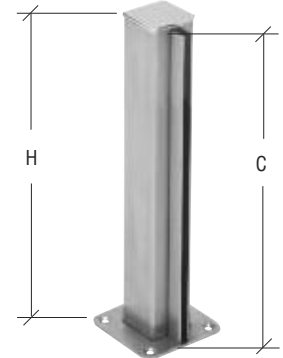

Round Z-Clamps for Flat Back Models Only



1/4" (6 mm) Glass Z-Clamp



3/8" (10 mm) Glass Z-Clamp



1/2" (12 mm) Glass Z-Clamp

H = Post Height _____"

T = Top of Post to Top of Upper Clamp _____"

B = Bottom of Lower Clamp to Surface of Counter _____"

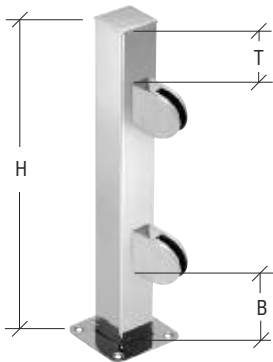

Square Z-Clamps for Flat Back Models Only



1/4" (6 mm) Glass Z-Clamp



3/8" (10 mm) Glass Z-Clamp



1/2" (12 mm) Glass Z-Clamp

H = Post Height _____"

T = Top of Post to Top of Upper Clamp _____"

B = Bottom of Lower Clamp to Surface of Counter _____"

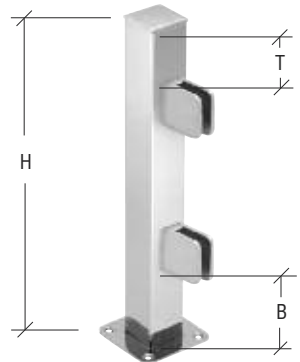

Glass Clips



1/4" (6 mm) Glass Clip



3/8" (10 mm) Glass Clip

H = Post Height _____"

T = Top of Post to Top of Upper Clip _____"

B = Bottom of Lower Clip to Surface of Counter _____"

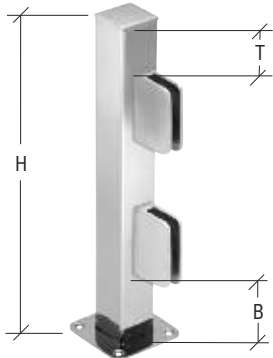

Custom Designed Posts

Need something special in a Partition Post or Sneeze Guard? Ask CRL! Our Technical Sales Department can offer you detailed diagrams and layout sheets for just about any job. Contact CRL Technical Sales at (800) 421-6144 in the U.S., (877) 421-6144 from Canada, or (323) 588-1281 International. Ask for Ext. 7760. You can also e-mail us through our web site at crlaurence.com. From the home page click on Contact Us, and then click on Technical Sales.



CRL Plaza Series Custom Square Partition Posts Quote/Order Form – Page 2 of 2

Select a Top Cap



Flat



Pyramid



See page P558

Select a Mounting Base



Welded Flange



Full Flange

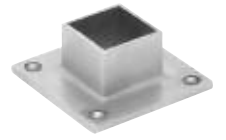

Lug Base



See page P563

Select Post Type and Quantity of Each

For Posts Using Glass U-Channel

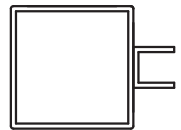

End
Quantity _____

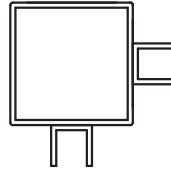

Corner
Quantity _____

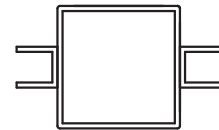

Center
Quantity _____

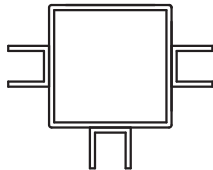

3-Way
Quantity _____

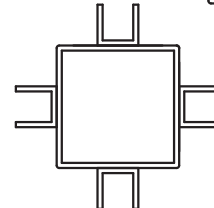

4-Way
Quantity _____

Glass is held in place by U-Channel mounted to the Partition Posts.

For Posts Using:

Glass Fittings

Glass Clips

Round
Z-Clamps

Square
Z-Clamps



Glass is held in place with Clips, Clamps or Fittings mounted to the Partition Posts. Diagrams below give you the option for placement of exposed screw heads.

End Posts

Left Hand

Quantity:

Right Hand End _____

Left Hand End _____

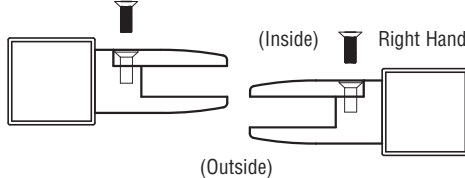

Center Posts

Quantity _____

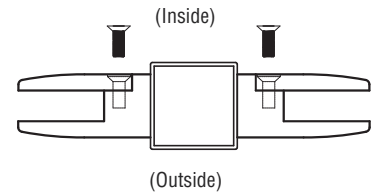

Corner Posts

Quantity:

90 Degree Regular _____

90 Degree Reverse _____

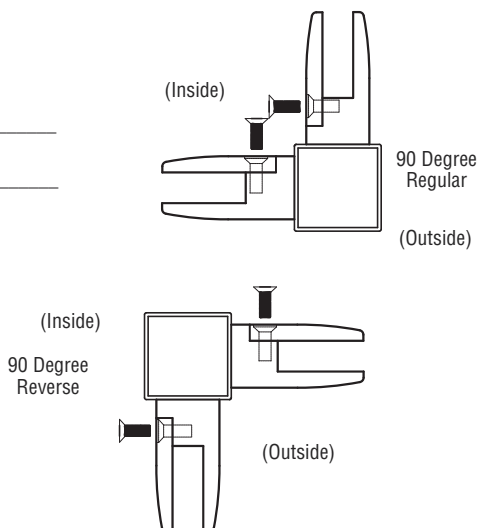

3-Way Posts

For Z-Clamps and Glass Clips only.

Mark one side of each clamp for the exposed screw location.

Quantity _____

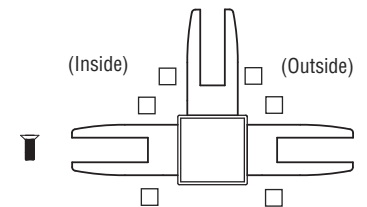

4-Way Posts

For Z-Clamps and Glass Clips only.

Mark one side of each clamp for the exposed screw location.

Quantity _____

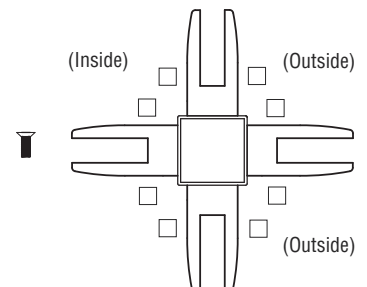



CRL Elegant and Contemporary Series Custom Round Partition Posts

- 1-1/2" and 2" (38.1 and 50.8 mm) Round Tubing for Use With 1/4", 3/8" or 1/2" (6, 10 or 12 mm) Glazing
- Heights of Posts Can Be Customized
- Available in Polished Stainless Steel, Brushed Stainless Steel, and Polished Brass

• Posts Ready to Ship in Three to Five Days From Los Angeles



<p>U-Channel for 1-1/2" or 2" Tubing (See Page P564)</p> <p>1/4" (6 mm) 3/8" (10 mm)</p>	<p>Z-Series Clamps for 2" Tubing Only. Limited Models for 1-1/2" (38 mm) Tubing (See Pages P568, P570)</p> <p>Round 1/4" (6 mm) Square 3/8" (10 mm) 1/2" (12 mm)</p>	<p>Glass Clips for 1-1/2" or 2" Tubing (See Page P566)</p> <p>1/4" (6 mm) 3/8" (10 mm)</p>	<p>End Load Standoff Fitting for 1-1/2" Tubing Only (See Page P565)</p> <p>1/4" (6 mm) to 3/8" (10 mm)</p>
<p>End Caps for 1-1/2" or 2" Tubing (See Pages P557, P559)</p> <p>Ball Flat Dome</p>	<p>Mounting Bases for 1-1/2" or 2" Tubing (See Pages P560 to P561)</p> <p>Full Flange Cut Flange Steel Flange and Canopy Concealed Base Lug</p>		<p>Welded or Brazed Mounting Base for 1-1/2" or 2" Tubing (See Page P562)</p> <p>Used with Full Length U-Channel</p>

In addition to our Stock and Custom "Quick Ship" Posts we offer an extensive line of Custom Fabricated Posts. They are available in 1-1/2" (38.1 mm) or 2" (50.8 mm) diameter Round Tubing. Finishes include Brushed Stainless, Polished Brass, Polished Stainless, and Powder Painted. Different glass attachments (U-Channel, Z-Clamps, Glass Clips or End Load Standoff Fittings) in various glass thicknesses are available. A selection of Caps and Bases let you design posts to match your décor. A step by step Quote/Order process is provided (see pages P554 to P555) to assist you in your selection. Custom Partition Posts will be fabricated and ready to ship from Los Angeles, California within three to five working days. CRL has weekly re-supply trucks that stock our many warehouses around the U.S. and Canada. If time is not an issue we can arrange for our re-supply truck to get your Custom Posts to your local CRL branch for shipment. Please allow seven to ten working days.

Plan View of Divider Assembly Showing Post Placement

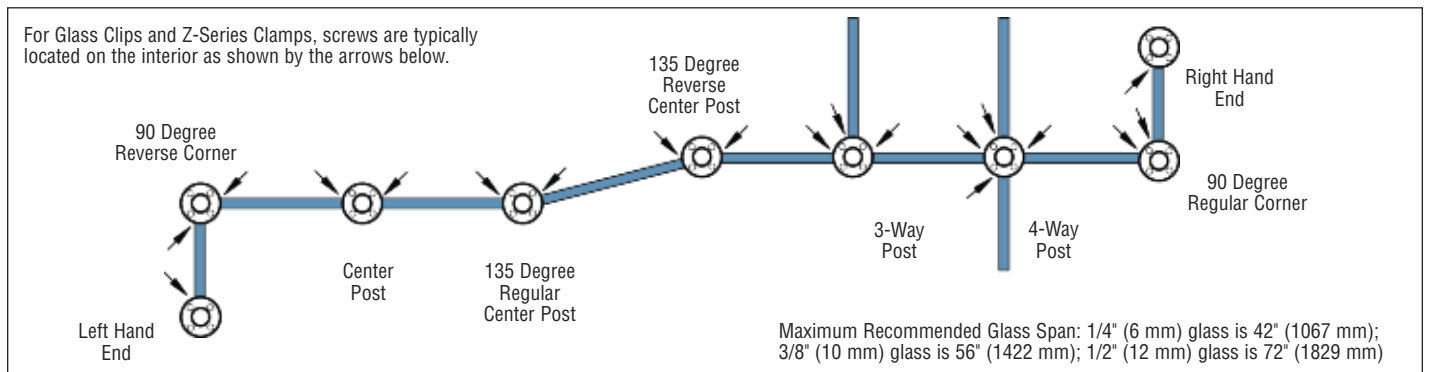

CRL Elegant and Contemporary Series Custom Round Partition Posts Quote/Order Form - Page 1 of 2



Select Tubing Diameter

See page P557

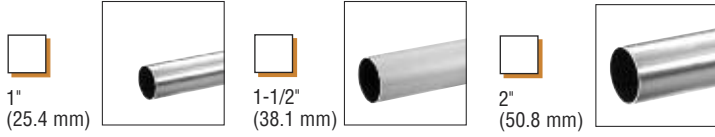

Select a Finish

- #4 Brushed Stainless*
- #8 Polished Stainless
- US3 Polished Brass
- Powder Paint
RAL Color # _____

This form is also available online at crlaurence.com.
* Only finish available for 1" (25.4 mm) Tube

Post Style and Dimensions

U-Channel with Bottom Air Space

- 1/4" (6 mm) Glass Channel
- 3/8" (10 mm) Glass Channel

H = Post Height _____"
C = Channel Length _____"
A = Air Space _____"

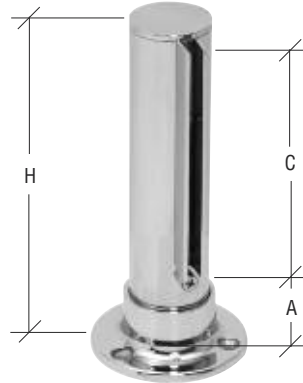

NOTE: If you have more than one style, use a separate form for each style.

Full Length U-Channel

- 1/4" (6 mm) Glass Channel
- 3/8" (10 mm) Glass Channel

H = Post Height _____"
C = Channel Length _____"

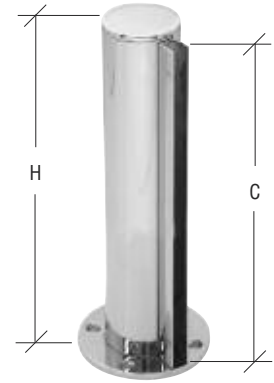

NOTE: Only available on Stainless or Brass Posts with Welded Base Plates.

Round Z-Clamps for 1", 1-1/2" and 2" (25.4, 38.1 and 50.8 mm) Tubing*

- 1/4" (6 mm) Glass Z-Clamp
- 3/8" (10 mm) Glass Z-Clamp
- 1/2" (12 mm) Glass Z-Clamp

H = Post Height _____"
T = Top of Post to Top of Upper Clamp _____"
B = Bottom of Lower Clamp to Surface of Counter _____"

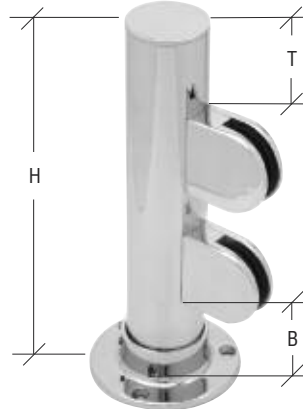

Square Z-Clamps for 2" (50.8 mm) Tubing

- 1/4" (6 mm) Glass Z-Clamp
- 3/8" (10 mm) Glass Z-Clamp
- 1/2" (12 mm) Glass Z-Clamp

H = Post Height _____"
T = Top of Post to Top of Upper Clamp _____"
B = Bottom of Lower Clamp to Surface of Counter _____"

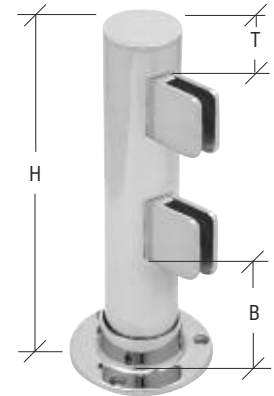

* Fittings for 2" (50.8 mm) Tubing are available in all finishes; for 1-1/2" (38.1 mm) Tubing brushed and polished stainless finishes only; for 1" (25.4 mm) Tubing brushed stainless finish only.

1" Diameter End Load Standoff Fitting for 1" and 1-1/2" (25.4 and 38.1 mm) Tubing

NOTE: This fitting matches Contemporary Series and Slimline Series Post*

- 1/4" (6 mm) Glass Fitting
- 3/8" (10 mm) Glass Fitting

H = Post Height _____"
T = Top of Post to Top of Upper Fitting _____"
B = Bottom of Lower Fitting to Surface of Counter _____"

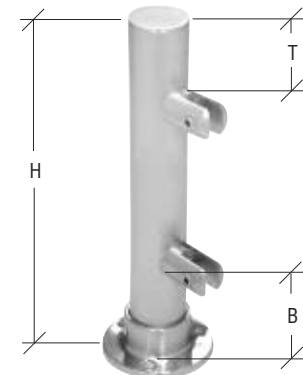

Glass Clips for 1-1/2" and 2" (38.1 and 50.8 mm) Tubing

- 1/4" (6 mm) Glass Clip
- 3/8" (10 mm) Glass Clip

H = Post Height _____"
T = Top of Post to Top of Upper Clip _____"
B = Bottom of Lower Clip to Surface of Counter _____"

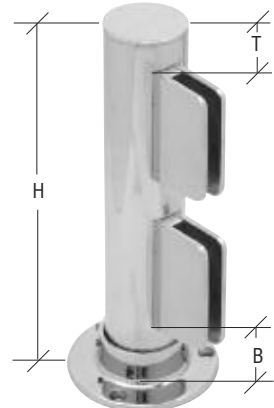

* Fittings for 1-1/2" (38.1 mm) Tubing are available in all finishes, for 1" (25.4 mm) Tubing Brushed Stainless Finish only.

CRL Elegant and Contemporary Series Custom Round Partition Posts Quote/Order Form - Page 2 of 2

Select a Top Cap



*Flat



Ball



Dome



*Only Cap available for 1" (25.4 mm) Tube
See pages P557, P559

Select a Mounting Base



Welded Flange



Cut Flange



*Full Flange



Steel Flange and Canopy



Concealed Base Lug



*Only Base available for 1" (25.4 mm) Tube

See pages P560 to P562

Select Post Type and Quantity of Each

Glass is held in place by U-Channel mounted to the Partition Posts.

For Posts Using Glass U-Channel



End
Quantity _____

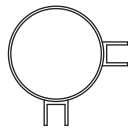

Corner
Quantity _____

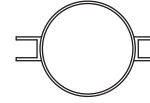

Center
Quantity _____



135 Degree
Quantity _____

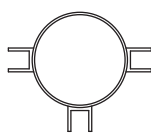

3-Way
Quantity _____

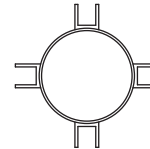

4-Way
Quantity _____

For Posts Using:

Glass Clips

Z-Clamps

End Load
Standoff Fittings



Glass is held in place with Clips, Clamps or Fittings mounted to the Partition Posts. Diagrams below give you the option for placement of exposed screw heads.

End Posts

Quantity:

Right Hand End _____

Left Hand End _____

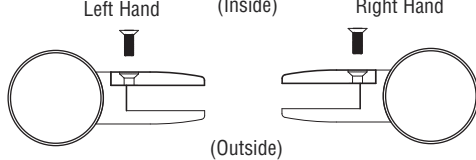

Center Posts

Quantity _____

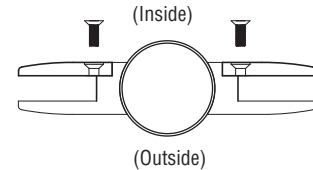

135 Degree Posts

Quantity:

135 Degree Regular _____

135 Degree Reverse _____

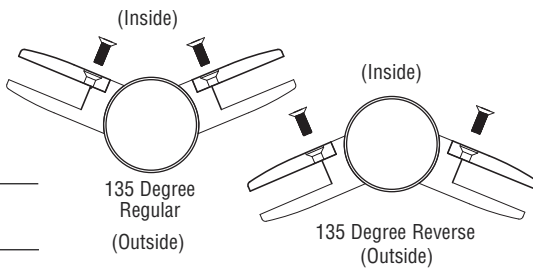

3-Way Posts

For Z-Clamps and Glass Clips only.

Mark one side of each clamp for the exposed screw location.

Quantity _____

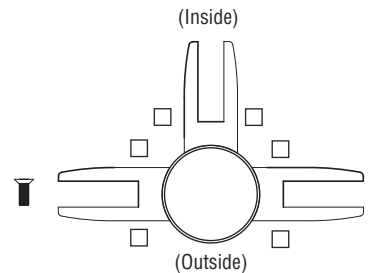

Corner Posts

Quantity:

90 Degree Regular _____

90 Degree Reverse _____

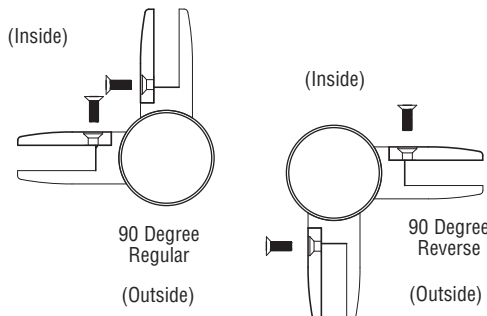

4-Way Posts

For Z-Clamps and Glass Clips only.

Mark one side of each clamp for the exposed screw location.

Quantity _____

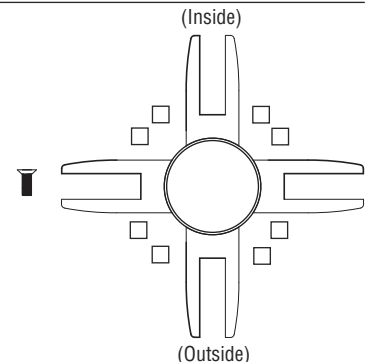

How Our Technical Sales Team Can Help You

It's sometimes difficult to satisfy all the different local building codes throughout the country. We find most local building and health departments use certain common standards as their own. CRL Technical Sales experts will work with you to design a unit that will meet these local standards.

CRL can help you customize a unit that not only meets your needs, but also falls within your budget. We encourage you to contact us to guide you through your design needs. Contact Technical Sales at (800) 421-6144 in the U.S., (877) 421-6144 from Canada, or (323) 588-1281 International, ask for Ext. 7760. You can also e-mail us through our web site at crlaurence.com. Click on Contact Us, and then click on Technical Sales for Hospitality Products.



Technical Sales

We will discuss your needs, advise you of the "do's and don'ts", and submit the design for a quote on your project in a timely manner. A name and phone extension will always be provided should you have additional questions.



Quoting Your Job

After all of the details have been worked out our Quotations Department will calculate your price and fax or e-mail you an initial quote for review and approval.

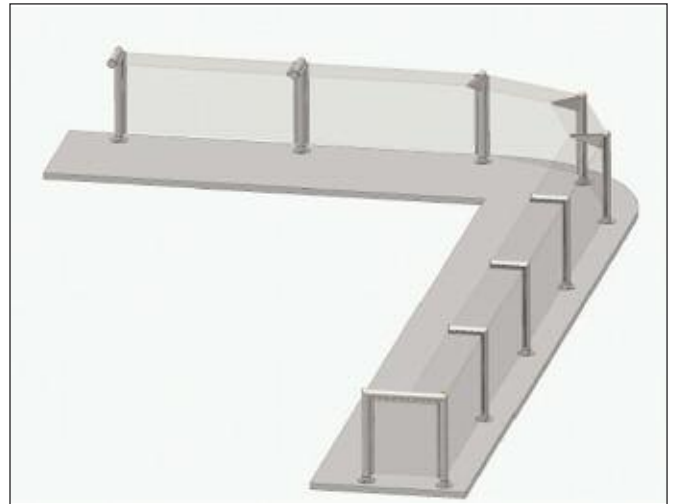
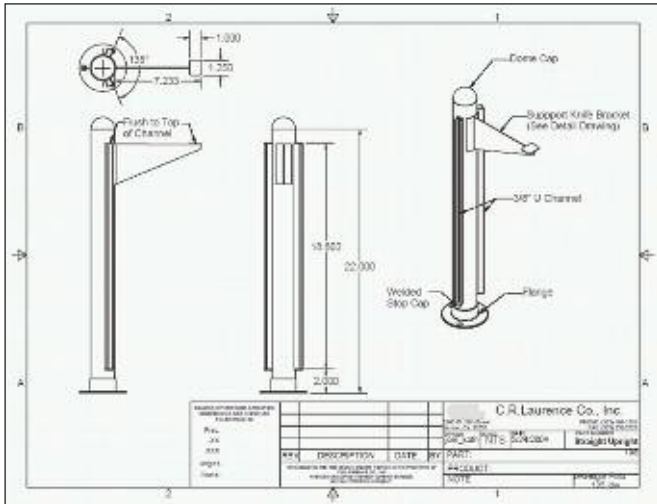

Engineering

After the initial quote has been accepted, detailed drawings will be provided for your approval. After the drawings are approved, production scheduling will be done to have your product ready to ship within 7 to 10 working days from our Los Angeles, California manufacturing facility or we can put them on our weekly re-supply truck to your local CRL warehouse for shipment or Will Call pick-up.

CRL Stock, Custom "Quick Ship", and Custom Sneeze Guards

- Stock Sneeze Guards Ready to Ship (See Page P577)
- Custom Sneeze Guards Ship Within Seven to Ten Working Days
- "Build Your Own Sneeze Guards" Using Stock Components Ready to Ship
- Send CRL Your Designs and Plans for Custom Sneeze Guards
- Technical Sales Staff Ready to Assist You With Design Ideas



C.R. Laurence Company has been in the glass and glazing supply business for over 40 years, and we continue to grow each year by listening to you, our customers. We are constantly looking at ways we can do things better, and are always striving to keep our customers satisfied. That is why CRL warehouses throughout the United States, Canada, Australia, and Europe are unmatched when it comes to customer service.

When Hospitality Sneeze Guards or Food Shields are required on a project, who better to turn to than CRL for all your "On-Time" delivered merchandise?

Most of our Sneeze Guards are made from our vast selection of stock component parts allowing for "Quick Ship" on complete units within three to five working days. However, with over 600,000 square feet of manufacturing capacity and trained technicians, CRL can fabricate any Custom Sneeze Guard System you design within seven to ten working days, ready to ship from Los Angeles, California.

CRL has a fully dedicated Technical Sales Staff willing to assist you with design ideas, price quotations, and ordering. CRL Technical Sales is available at (800) 421-6144 in the U.S., (877) 421-6144 from Canada, or (323) 588-1281 International. Ask for Ext. 7760.

Send CRL Your Custom Sneeze Guard Drawing and We Can Fabricate Exactly to Your Specifications

